

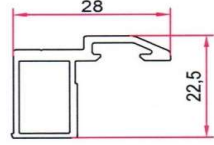

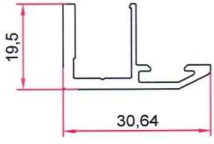

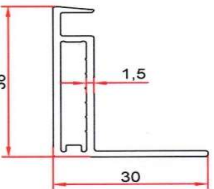
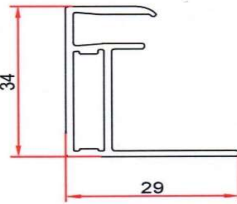
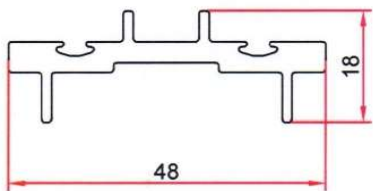

ARTE

ARTE ALUMİNYUM
SAN. VE. TİC. LTD. ŞTİ.

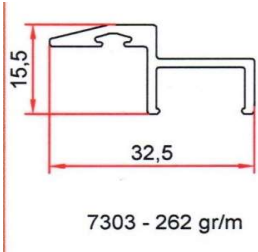
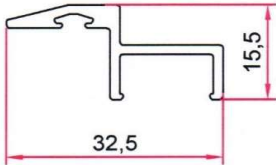
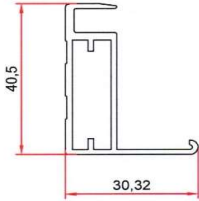
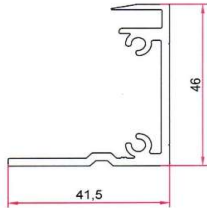
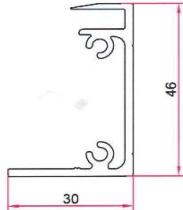
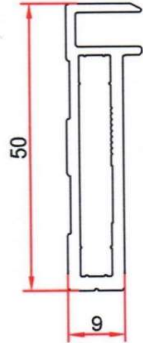
ARTE-B-DSG-02 SOLAR PRODUCT CATALOG

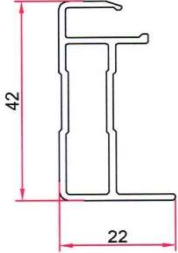
PRODUCT NAME	PRODUCT NUMBER	WEIGHT (gr/m)	PRODUCT DIMENSIONS (mm)
FRAME	D22-1-0001-2-3164	317	 3164 - 317 gr/m
FRAME	D22-1-0002-2-3165	356	 3165 - 356 gr/m
FRAME	D22-1-0003-2-2719	437	 2719 - 437 gr/m
FRAME	D22-1-0004-2-3015	412	 3015 - 412gr/m
FRAME	D22-1-0005-2-7300	632	 7300 - 632 gr/m

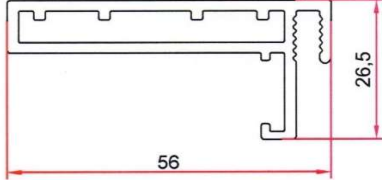
FRAME	D22-1-0006-2-7303	262	 <p>7303 - 262 gr/m</p>
FRAME	D22-1-0007-2-7304	259	 <p>7304 - 259 gr/m</p>
FRAME	D22-1-0008-2-7327	492	 <p>7327 - 492 gr/m</p>
FRAME	D22-1-0009-2-7557	737	 <p>7557 - 737 gr/m</p>
FRAME	D22-1-0010-2-7558	613	 <p>7558 - 613 gr/m</p>
FRAME	D22-1-0011-2-7240	562	 <p>7240 - 562 gr/m</p>

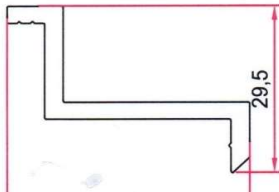
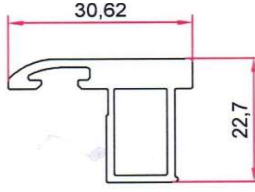
FRAME	D22-1-0012-2-7025	429	 <p>7025 - 429 gr/m</p>
FRAME	D22-1-0013-2-6887	998	 <p>6887 - 998 gr/m</p>
FRAME	D22-1-0014-2-6893	833	 <p>6893 - 833 gr/m</p>
FRAME	D22-1-0015-2-6951	635	 <p>6951 - 635 gr/m</p>
FRAME	D22-1-0016-2-6998	521	 <p>6998 - 521 gr/m</p>
FRAME	D22-1-0017-2-6759	496	 <p>6759 - 496 gr/m</p>

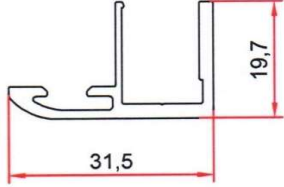
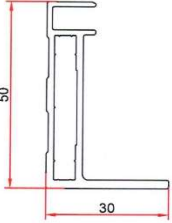
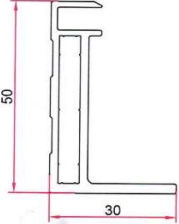
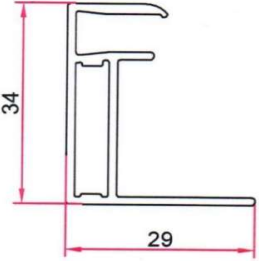
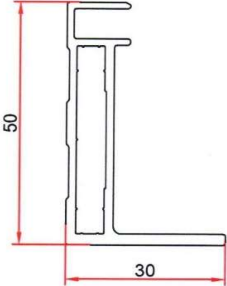
FRAME	D22-1-0018-2-6760	366	 <p>6760 - 366 gr/m</p>
FRAME	D22-1-0019-2-3794	640	 <p>3794 - 640 gr/m</p>
FRAME	D22-1-0020-2-3634	714	 <p>3634 - 714 gr/m</p>
FRAME	D22-1-0021-2-3375	412	 <p>3375 - 412gr/m</p>
FRAME	D22-1-0022-2-3794	640	 <p>3794 - 640 gr/m</p>

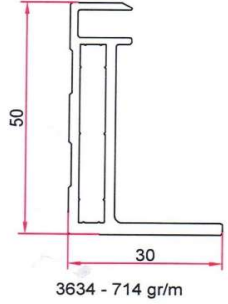
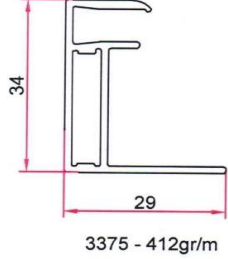
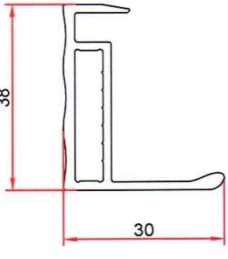
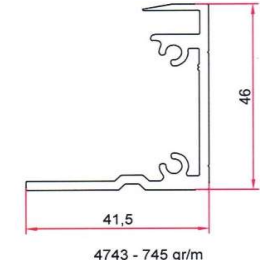
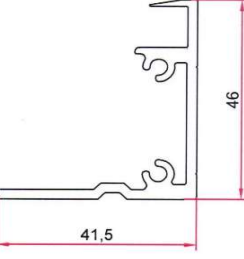
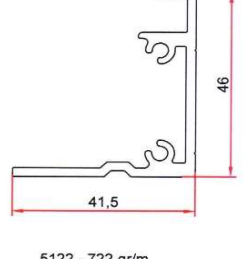
FRAME	D22-1-0023-2-3634	714	 <p>3634 - 714 gr/m</p>
FRAME	D22-1-0024-2-3375	412	 <p>3375 - 412gr/m</p>
FRAME	D22-1-0025-2-4938	527	 <p>4938 - 527 gr/m</p>
FRAME	D22-1-0026-2-4743	745	 <p>4743 - 745 gr/m</p>
FRAME	D22-1-0027-2-5181	721	 <p>5181 - 721 gr/m</p>
FRAME	D22-1-0028-2-5122	722	 <p>5122 - 722 gr/m</p>

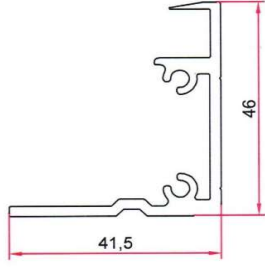
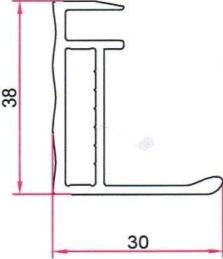
FRAME	D22-1-0029-2-5343	721	 <p>5343 - 721 gr/m</p>
FRAME	D22-1-0030-2-5862	541	 <p>5862 - 541 gr/m</p>